

Welcome to our Wall post gate installation guide

1) Place your wall post where you want in on the wall
And use a level to check it is upright.

2) Mark with a pencil where the drill holes will be.
(Make sure you drill through the centre of the brick and evenly
stagger the holes from left to right as the picture shows)

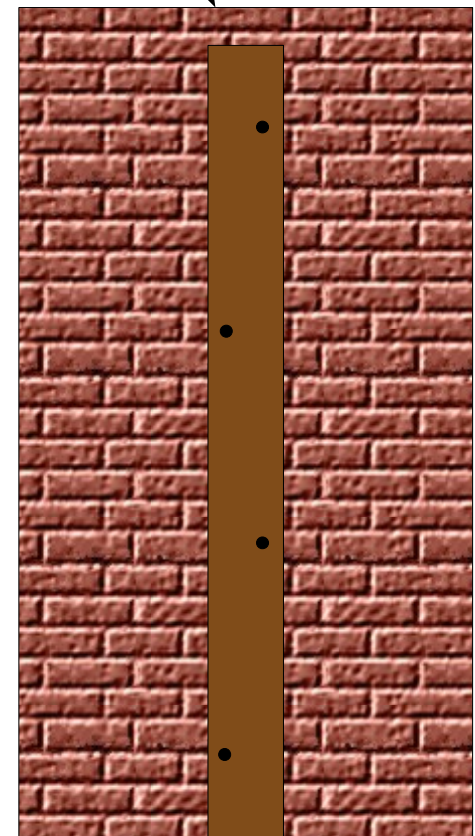
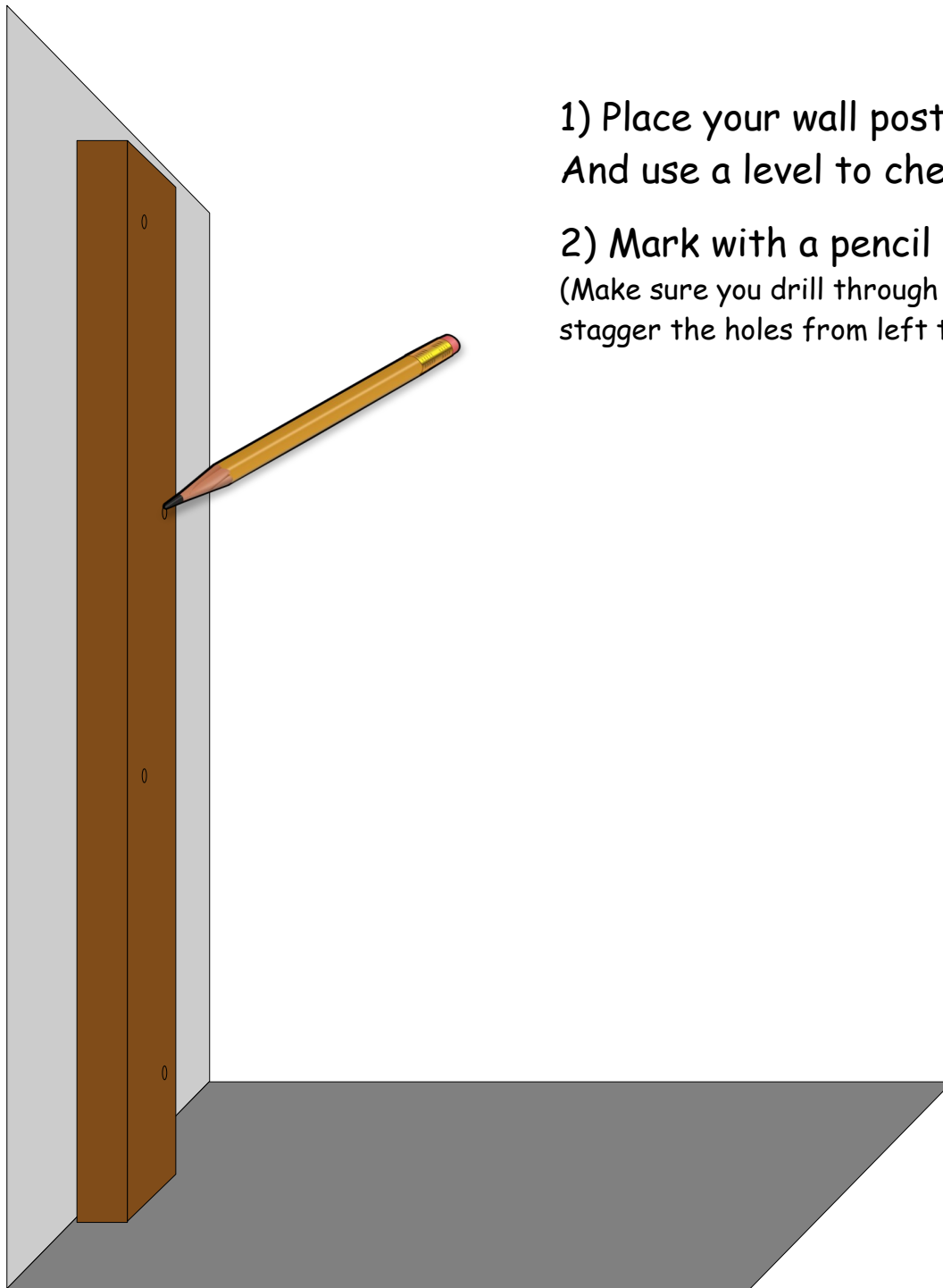

- Now you need to drill in approx 10mm deep with a 25mm flat wood bit (This is a countersink for the bolt head)
- Now change your drill bit for an 11-12mm standard wood or HSS Bit and drill through to the brick (Drill through just enough to mark the brickwork)

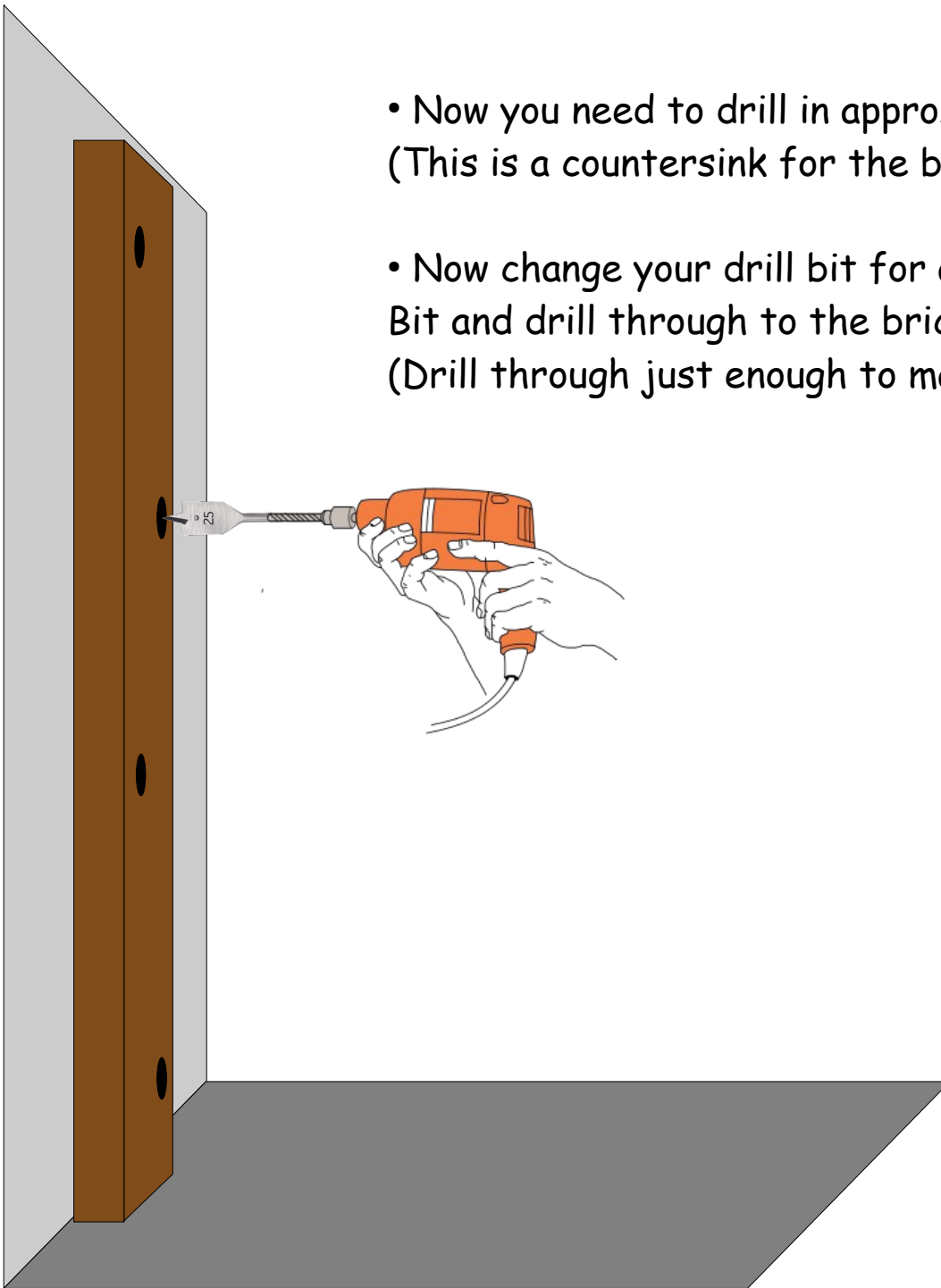

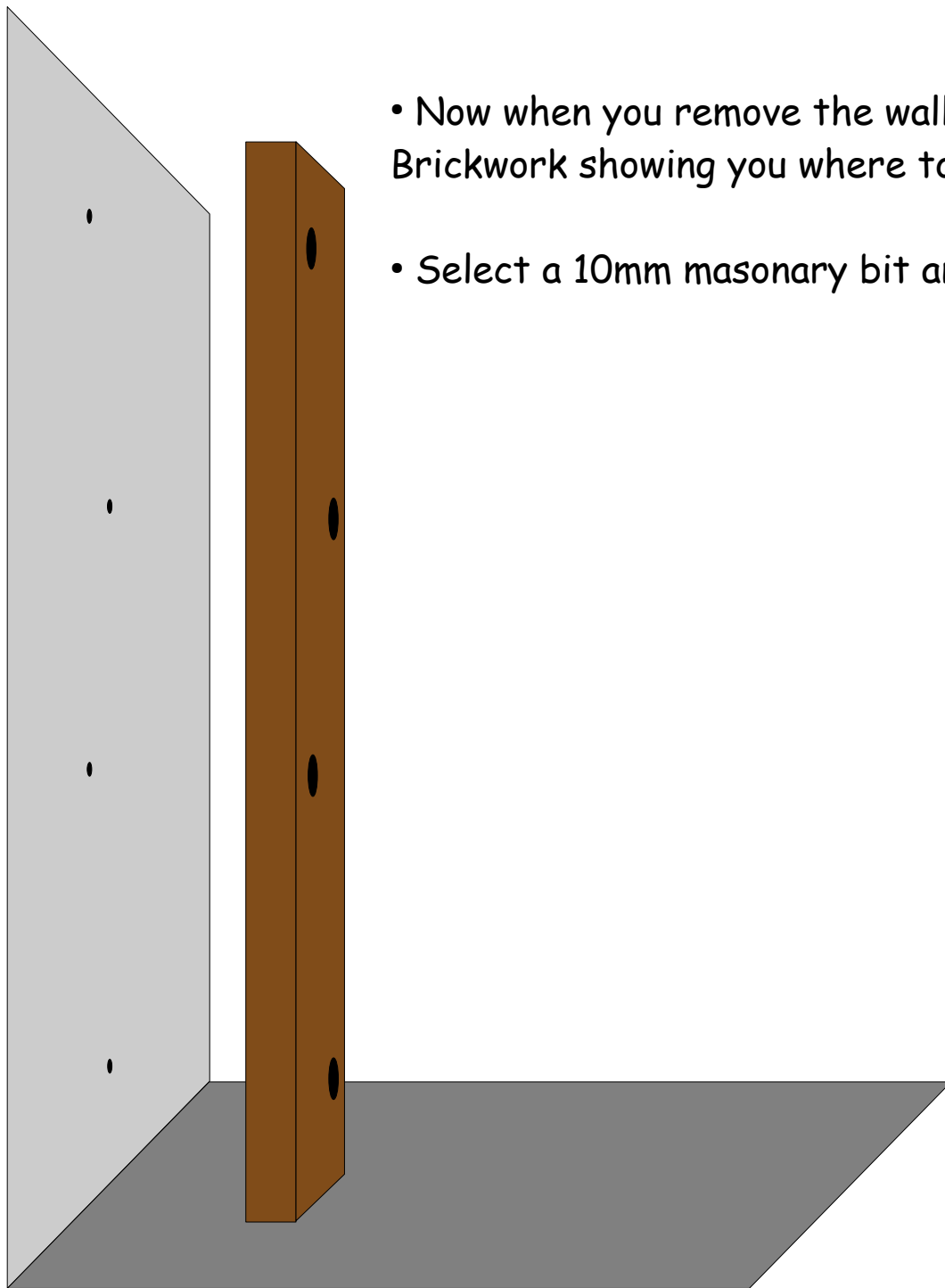

- Now when you remove the wall post you will have 4 marks in the Brickwork showing you where to drill
- Select a 10mm masonry bit and drill into the wall 80-85mm

Click on screen to Continue

- You are now ready to attach the Anchor Bolts to the wall post

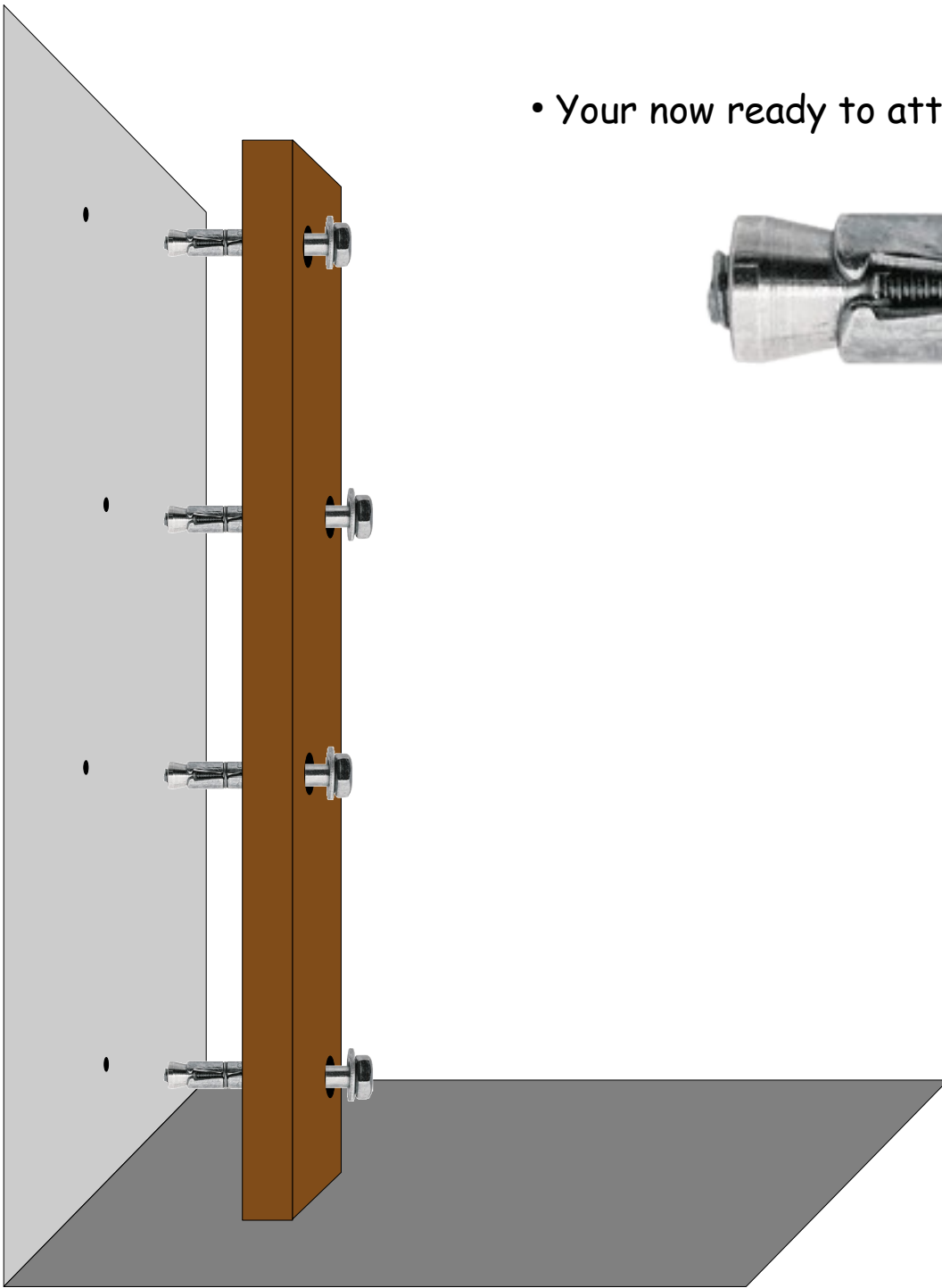

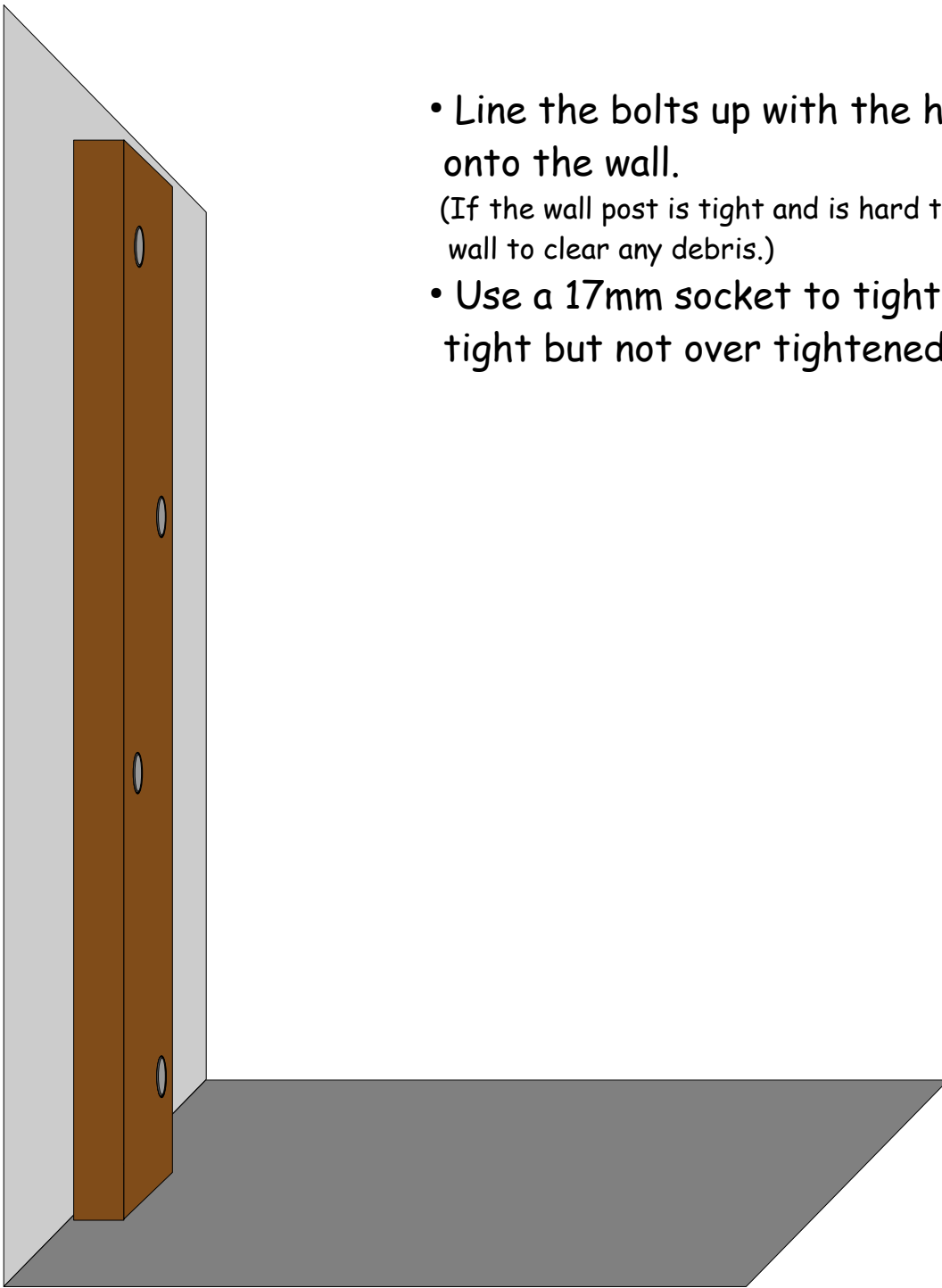

- Line the bolts up with the holes and gently push the wall post onto the wall.
(If the wall post is tight and is hard to push on, re-drill the holes in the wall to clear any debris.)
- Use a 17mm socket to tighten the bolts these should be reasonably tight but not over tightened.

- Do the same on the opposing wall making sure the tops of the wall posts are level with each other.
(As you can see from the drawing, if the ground is un-even it is important the tops remain level)

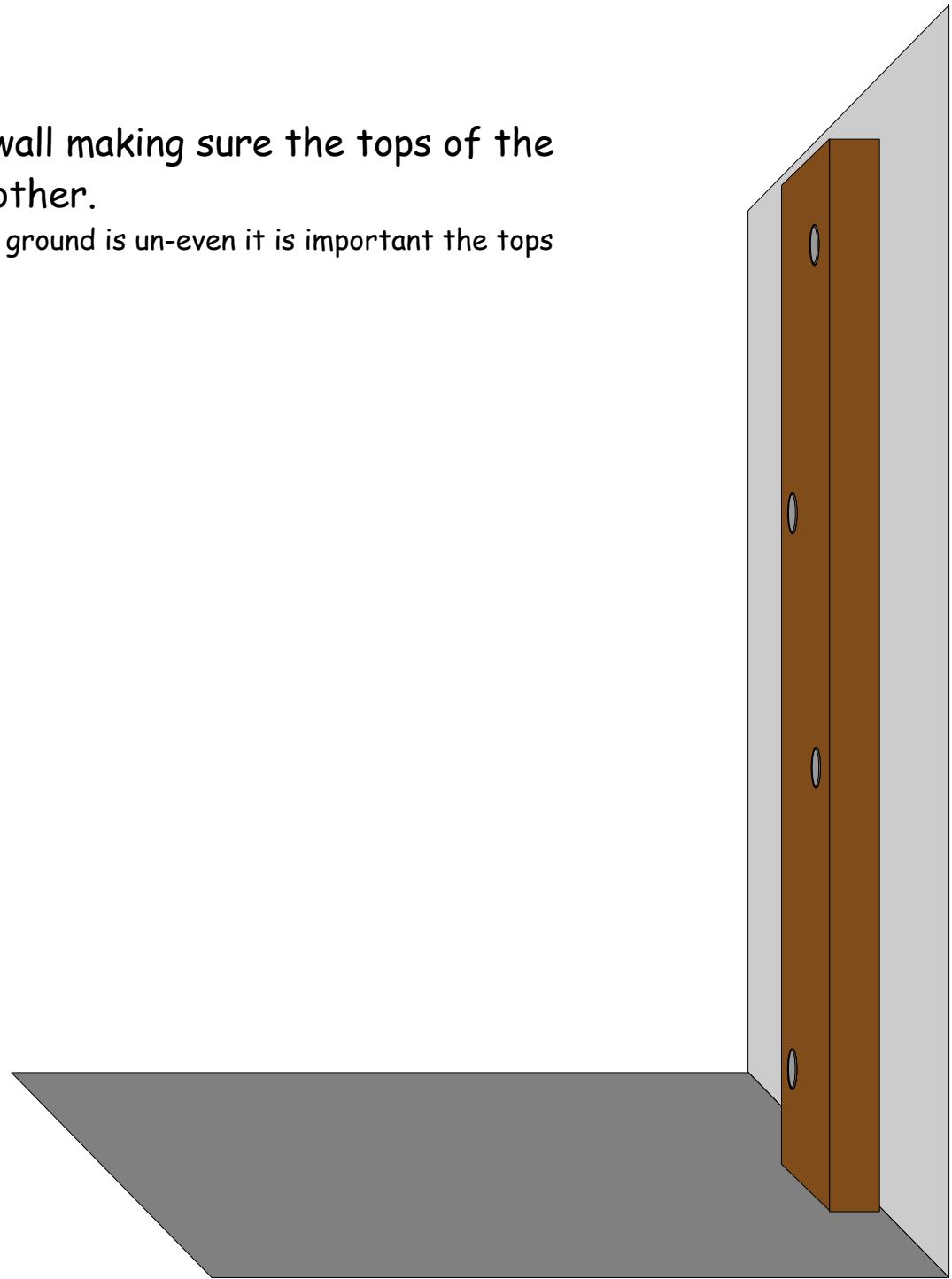
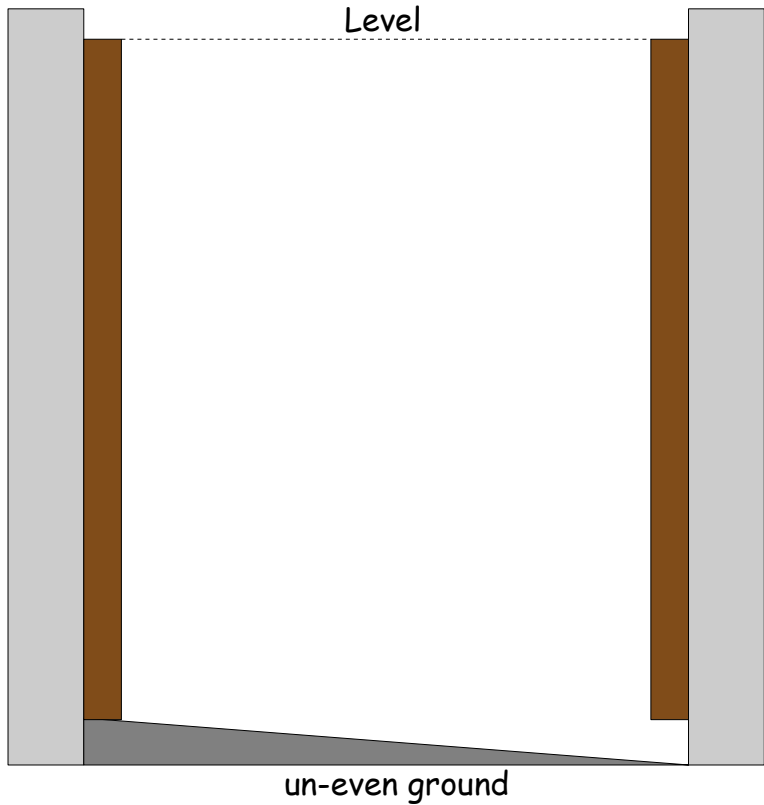

- You can now stand your gate in place and use some wood or wedges to raise it off the ground and get it level

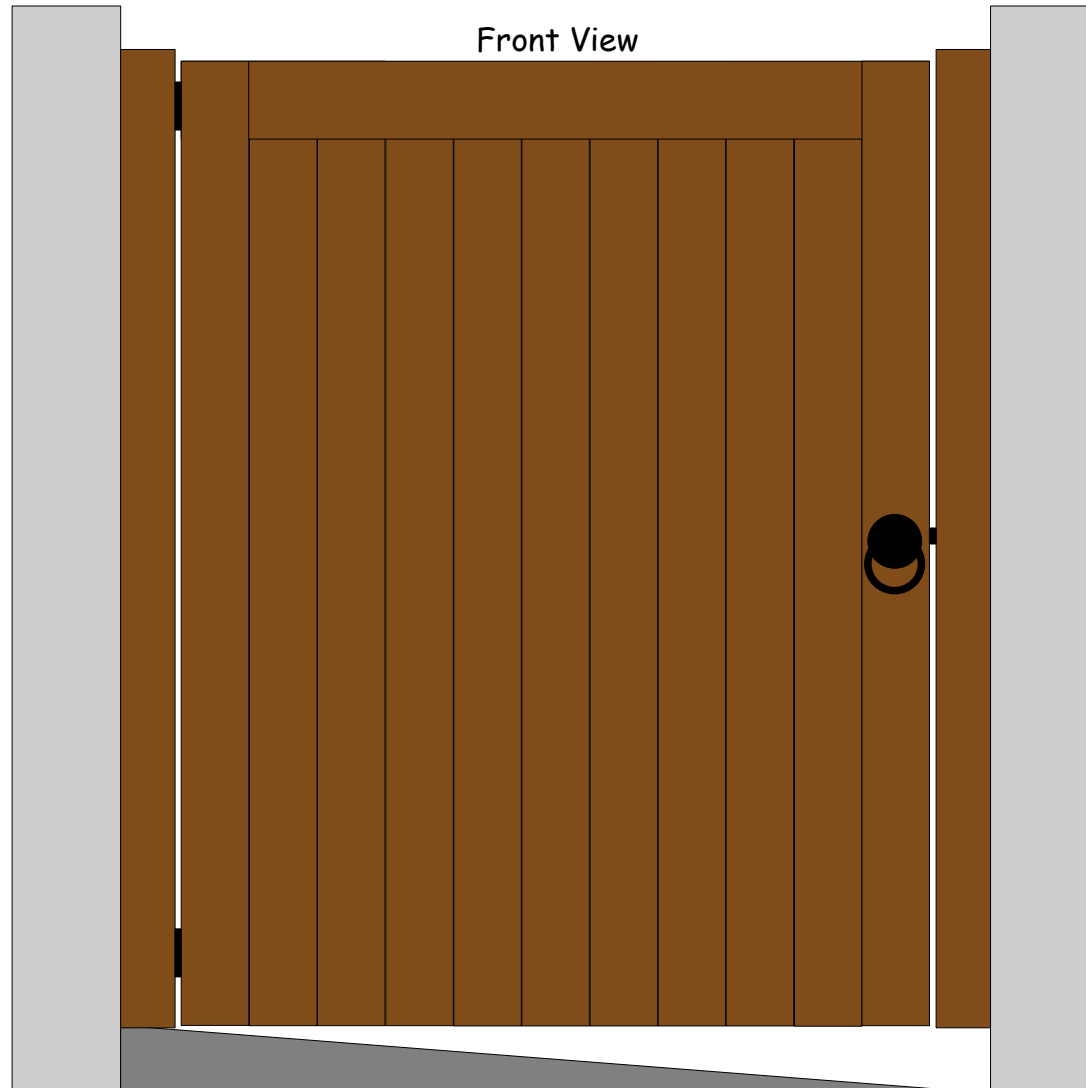

- Finally screw your hinges onto the wall posts, adjust the hinges to get the gate level and fit the closing catch.

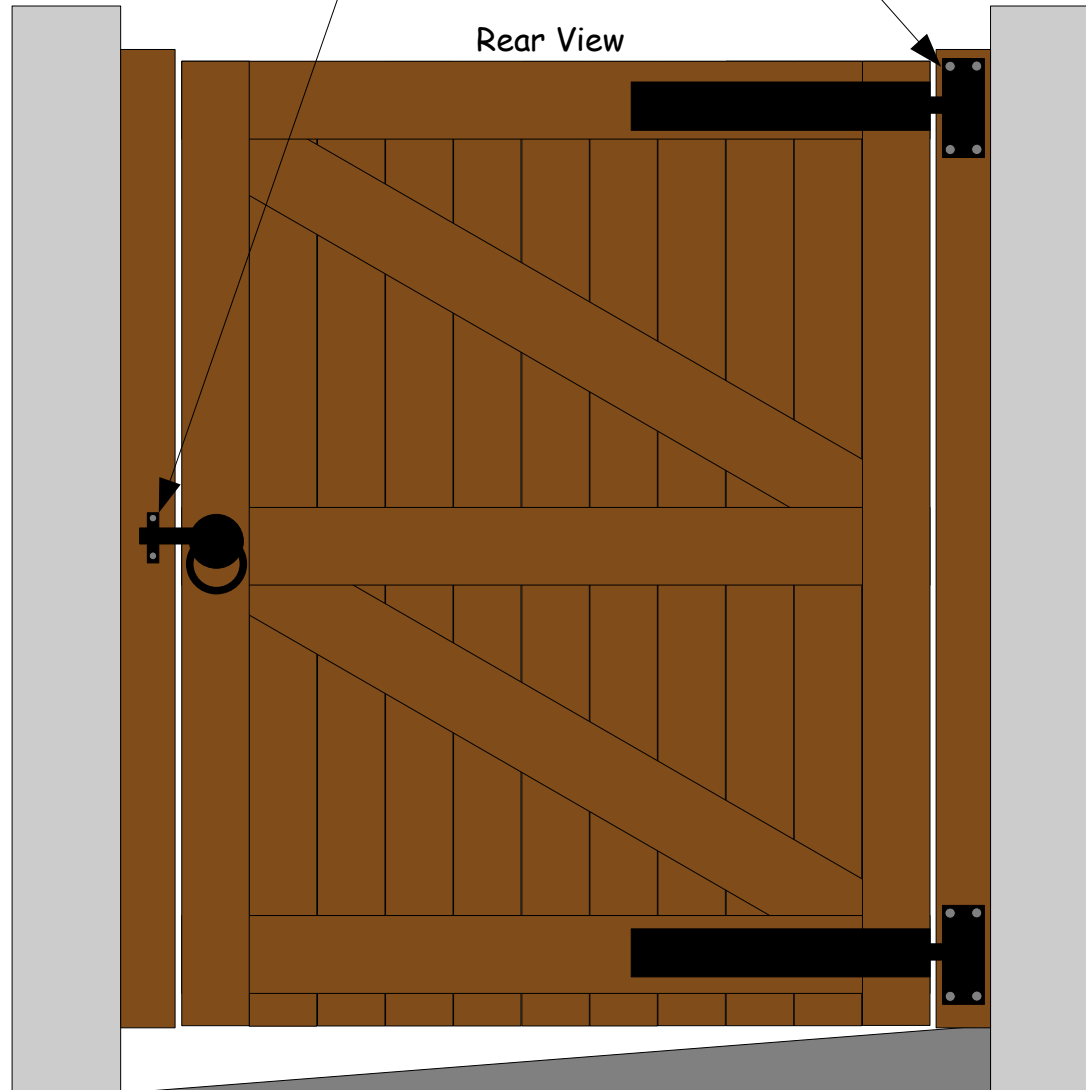

Congratulations
You have finished the job

Now just close this window to return to our website